

REV	DESCRIPTION	DATE	DESIGNED
1			

Circuit	Dimensions		
	A	B	C
2	1.25	3.75	5.75
3	2.50	5.00	7.00
4	3.75	6.25	8.25
5	5.00	7.50	9.50
6	6.25	8.75	10.75
7	7.50	10.00	12.00
8	8.75	11.25	13.25
9	10.00	12.50	14.50
10	11.25	13.75	15.75
11	12.50	15.00	17.00
12	13.75	16.25	18.25
13	15.00	17.50	19.50
14	16.25	18.75	20.75
15	17.50	20.00	22.00

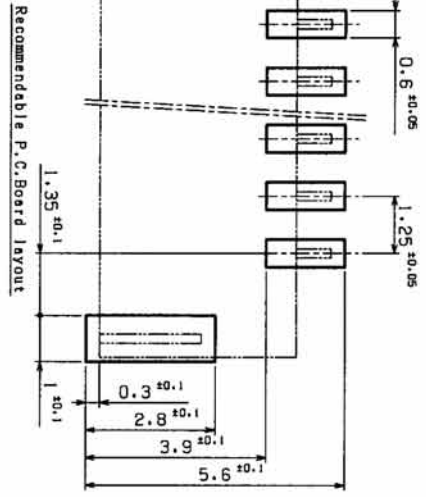

Recommendable P.C. Board layout

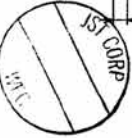
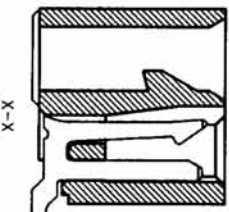
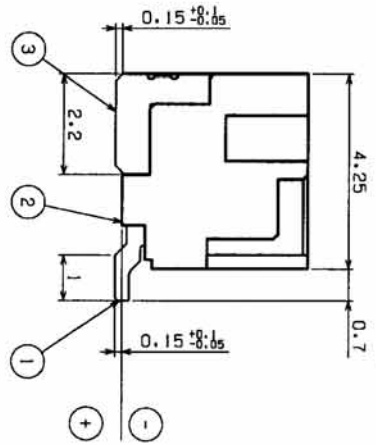
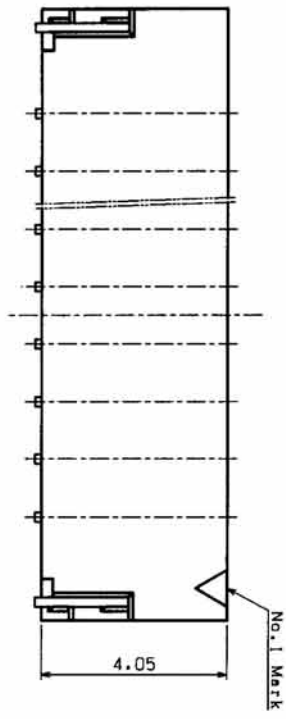
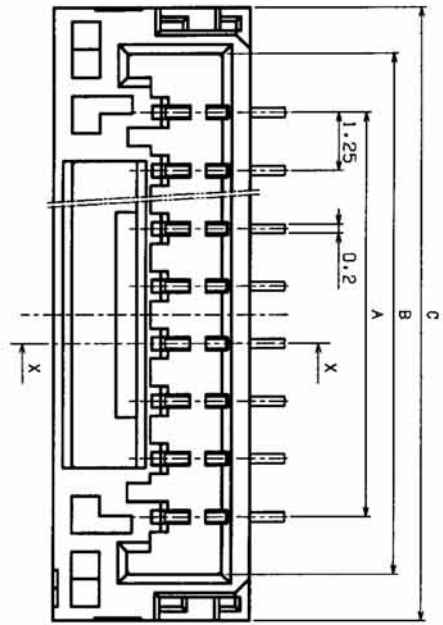

NOTE
 1. Unless otherwise specified, tolerances are 0.05 ± 0.15
 1.0 ± 0.3 , 0.1 ± 0.2
 3.0 ± 0.3
 2. Coplanarity of contact solder tails is 0.1 mm max.
 3. Tolerance of pattern pitch on PCB are not cumulative.

3	REINFORCEMENTS	BRASS	COPPER-UNDERPLATED TIN-PLATED	± 0.2	UL94V-0, NATURAL
2	WAFER	9T NYLON			
1	HEADER PIN	PHOSPHOR BRONZE	COPPER-UNDERPLATED TIN-PLATED	± 0.2	
NO. PART NAME		MATERIAL		REMARKS	
SIZE UNIT SCALE		PRODUCTION DATE		CUSTOMER	
A3 METRIC 10:1		JAN. 17, 2005			
APPROVED CHECKED		DESIGNED DRAWN		SERIES	
T. N S. S		T. T M. Y		GH CONNECTOR TOP TYPE HEADER	
				PART NO. BM () B-GHS (LP) (SN)	
				DRAWING NO. KR0-32980-3	
				RO	

THIS DRAWING CONTAINS INFORMATION THAT IS PROPRIETARY TO J.S.T. AND SHOULD NOT BE USED WITHOUT WRITTEN PERMISSION.

EC4109-2

REV	DESCRIPTION	DATE	DESIGNED
1	ADDITION OF NUMBER OF CIRCUITS	OCT.13.2004	T.T
2	ADDITION OF NUMBER OF CIRCUITS	DEC.22.2004	T.T

Circuits	Dimensions							
	A	B	C	D	E	F	G	H
2	6.0	3.0	16.0	7.5	-	17.5	5.55	9.1
3	7.3	4.3	24.0	11.5	-	25.5	6.80	10.4
4	8.5	5.5	24.0	11.5	-	25.5	8.05	11.6
5	9.8	6.8	24.0	11.5	-	25.5	9.30	12.9
6	11.0	8.0	24.0	11.5	-	25.5	10.55	14.1
7	12.3	9.3	24.0	11.5	-	25.5	11.80	15.4
8	13.5	10.5	24.0	11.5	-	25.5	13.05	16.6
9	14.8	11.8	24.0	11.5	-	25.5	14.30	17.9
10	16.0	13.0	32.0	14.2	28.4	33.5	15.55	19.1
11	17.3	14.3	32.0	14.2	28.4	33.5	16.80	20.4
12	18.5	15.5	32.0	14.2	28.4	33.5	18.05	21.6
13	19.8	16.8	44.0	20.2	40.4	45.5	19.30	22.9
14	21.0	18.0	44.0	20.2	40.4	45.5	20.55	24.1
15	22.3	19.3	44.0	20.2	40.4	45.5	21.80	25.4

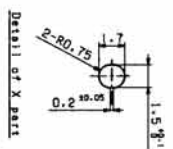
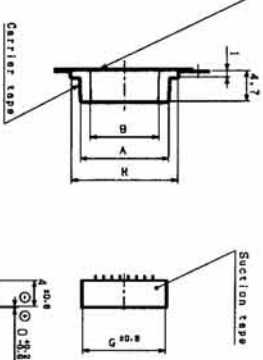
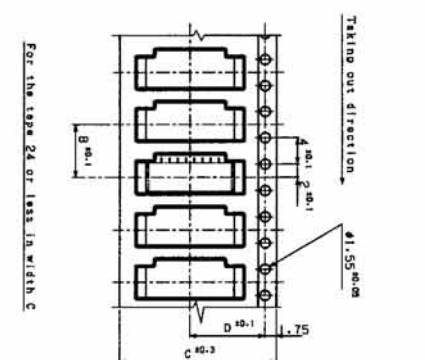
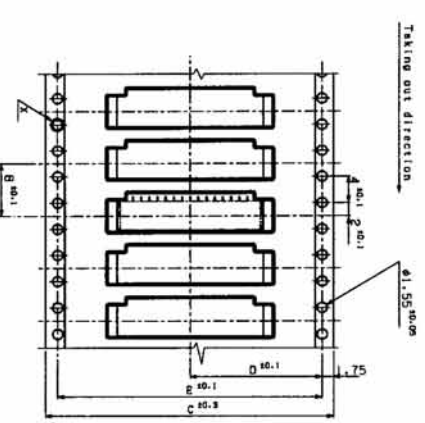
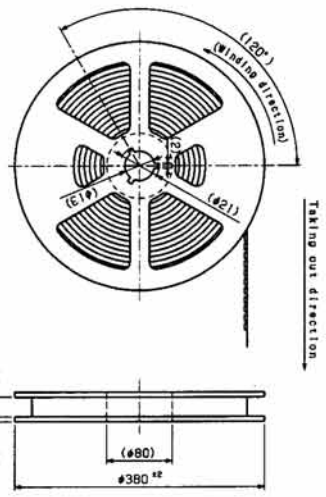

THIS DRAWING CONTAINS INFORMATION THAT IS PROPRIETARY TO J.S.T. AND SHOULD NOT BE USED WITHOUT WRITTEN PERMISSION.

NO.	PART NAME	MATERIAL	SURFACE FINISH	REMARKS
A2	METRIC 2:1	AUG.16.2004		
T.N	S.S	T.T	M.Y	
GH CONNECTOR TOP TYPE EMBOSSSED-TAPING PRODUCT BM (18-CHS-T9T (LP) (SN)				
KRD-34658 R2				

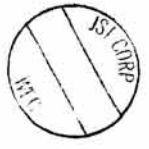

ES413-2