

Solderless terminals

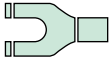

FLANGED SPADE TONGUE (B type) Non-insulated

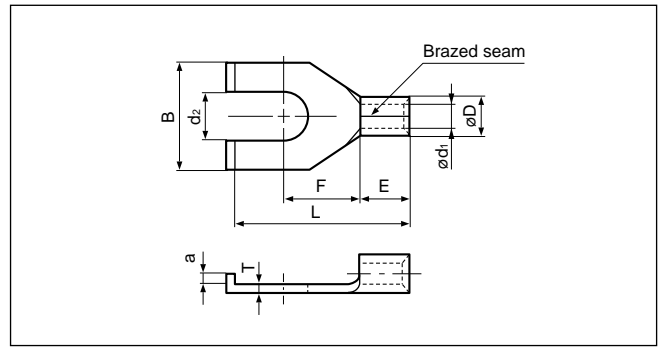
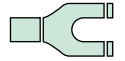

Certificate No.: E42024 LR20812

| Applicable Wire AWG# (mm ²) | Stud size | | Part No. | Standard | Dimensions mm (in.) | | | | | | | | | Tool No. | Qty/box |
|--|-----------|--------|-----------|----------|---------------------|-------------|--------------|-------------|---------------|---------------|---------------|---------------|---------------|---|---------|
| | American | Metric | | | dz | B | L | F | E | øD | ød1 | a | T | | |
| 22 to 16 (0.25 to 1.65) | 5-6 | 3.5 | 1.25-YS3B | | 3.7 (.146) | 6.4 (.252) | 14.2 (.559) | 6.3 (.248) | 4.8 (.189) | 3.4 (.134) | 1.7 (.067) | 0.8 (.031) | 0.8 (.031) | YHT-2210 YA-1 YA-2 YA-4 BCT-0514L | 1,000 |
| | 5-6 | 3.5 | 1.25-S3B | | 3.7 (.146) | 7.5 (.295) | 13.1 (.516) | 5.1 (.201) | | | | 1.5 (.059) | | | |
| | 8 | 4 | 1.25-YS4B | | 4.3 (.169) | 6.4 (.252) | 14.2 (.559) | 6.3 (.248) | | | | 0.8 (.031) | | | |
| | 8 | 4 | 1.25-S4B | | 4.3 (.169) | 7.5 (.295) | 13.1 (.516) | 5.1 (.201) | | | | 1.5 (.059) | | | |
| | 8 | 4 | 1.25-4B | | 4.3 (.169) | 8.5 (.335) | 18.5 (.728) | 7.2 (.284) | | | | | | | |
| | 10 | 5 | 1.25-5B | | 5.3 (.209) | 8.5 (.335) | 18.5 (.728) | 7.2 (.284) | | | | | | | |
| 16 to 14 (1.04 to 2.63) | 5-6 | 3.5 | 2-T3B | | 3.7 (.146) | 7.5 (.295) | 13.5 (.532) | 5.2 (.205) | 4.8 (.189) | 4.1 (.161) | 2.3 (.091) | 1.5 (.059) | 0.8 (.031) | YHT-2210 YA-1 YA-2 YA-4 BCT-0514L | 1,000 |
| | 5-6 | 3.5 | 2-3B | | 3.7 (.146) | 8.5 (.335) | 17.0 (.670) | 7.2 (.283) | | | | 1.5 (.059) | | | |
| | 8 | 4 | 2-T4B | | 4.3 (.169) | 7.5 (.295) | 13.5 (.532) | 5.2 (.205) | | | | 1.5 (.059) | | | |
| | 8 | 4 | 2-4B | | 4.3 (.169) | 8.5 (.335) | 17.0 (.670) | 7.3 (.287) | | | | | | | |
| | 10 | 5 | 2-5B | | 5.3 (.209) | 8.5 (.335) | 17.0 (.670) | 7.3 (.287) | | | | | | | |
| | 1/4 | 6 | 2-6B | | 6.4 (.252) | 13.5 (.532) | 24.0 (.945) | 11.7 (.461) | | | | | | | |
| 12 to 10 (2.63 to 6.64) | 5-6 | 3.5 | 5.5-S3B | | 3.7 (.146) | 7.6 (.299) | 18.0 (.709) | 6.2 (.244) | 6.8 (.268) | 5.6 (.221) | 3.4 (.134) | 1.5 (.059) | 1.0 (.039) | YHT-2210 YA-1 YA-2 YA-4 BCT-0514L | 500 |
| | 5-6 | 3.5 | 5.5-3B | | 3.7 (.146) | 8.5 (.335) | 19.5 (.768) | 7.5 (.295) | | | | 1.5 (.059) | | | |
| | 8 | 4 | 5.5-S4B | | 4.3 (.169) | 7.6 (.299) | 18.0 (.709) | 6.2 (.244) | | | | | | | |
| | 8 | 4 | 5.5-4B | | 4.3 (.169) | 8.5 (.335) | 19.5 (.768) | 7.5 (.295) | | | | | | | |
| | 10 | 5 | 5.5-5B | | 5.3 (.209) | 8.5 (.335) | 19.5 (.768) | 7.5 (.295) | | | | | | | |
| | 1/4 | 6 | 5.5-6B | | 6.4 (.252) | 13.5 (.532) | 26.5 (1.043) | 12.2 (.480) | | | | | | | |

Note:1) The part numbers indicated in the above table are for products with a brazed seam.
 When ordering products with a butted seam, add the prefix "WS" to the part number (ex. 2-4B → **WS2-4B**).
 2) Delivery lead times may vary depending on the product. Contact JST for details.

Solderless terminals

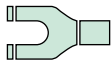

FLANGED SPADE TONGUE (B type) vinyl-insulated

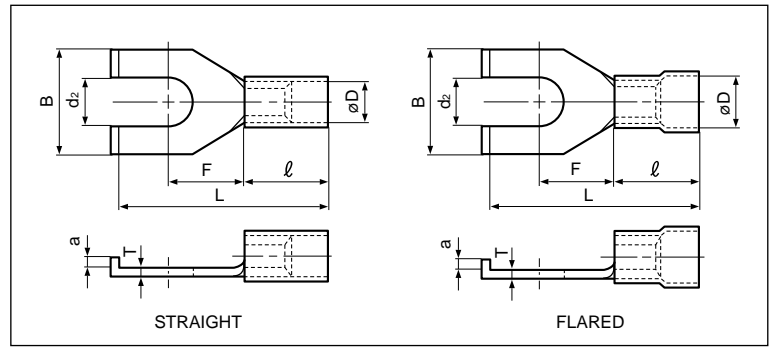
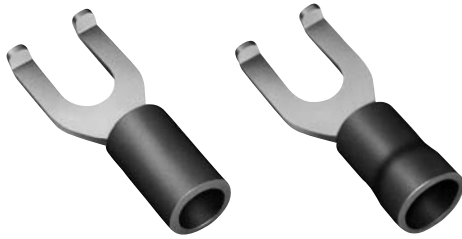
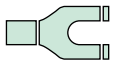

Certificate No.: E42024 LR20812

| Applicable Wire AWG#(mm ²) | Stud size | | Part No. | | Standard | Dimensions mm (in.) | | | | | | | | | | Color | Tool No. | Qty/box |
|---|-----------|--------|------------|------------|-------------|---------------------|-------------|---------------|-------------|---------------|----------------|---------------|---------------|---------------|--------|---|----------|---------|
| | American | Metric | Straight | Flared | | d ₂ | B | L | F | a | ℓ | ø D | | T | | | | |
| | | | | | | | | | | | | Str. | Fl. | | | | | |
| 26 to 22 (0.2 to 0.5) | 1-2 | 2 | V0.5-2B | FV0.5-2B | | 2.2 (.087) | 4.6 (.181) | 15.6 (.614) | 4.5 (.177) | 1.0 (.039) | 8.0 (.315) | 1.9 (.075) | 2.9 (.114) | 0.5 (.020) | Yellow | YNT-2622 YA-1, YA-2 BCT-0514L | 1,000 | |
| 22 to 16 *(0.25 to 1.65) | 5-6 | 3.5 | V1.25-S3B | FV1.25-S3B | | 3.7 (.146) | 7.5 (.295) | 17.3 (.681) | 5.1 (.201) | 1.5 (.059) | 9.0 (.354) | 3.2 (.126) | 4.0 (.157) | 0.8 (.031) | Red | YNT-2216 YA-1 YA-2 YA-4 BCT-0514L | 1,000 | |
| | 5-6 | 3.5 | V1.25-3B | FV1.25-3B | | 3.7 (.146) | 8.5 (.335) | 21.7 (.854) | 7.2 (.284) | | | | | | | | | |
| | 8 | 4 | V1.25-YS4B | - | | 4.3 (.169) | 6.4 (.252) | 18.4 (.724) | 6.3 (.248) | | | | | | | | | |
| | 8 | 4 | V1.25-S4B | FV1.25-S4B | | 4.3 (.169) | 7.5 (.295) | 17.3 (.681) | 5.1 (.201) | | | | | | | | | |
| | 8 | 4 | V1.25-4B | FV1.25-4B | | 4.3 (.169) | 8.5 (.335) | 22.7 (.894) | 7.2 (.284) | | | | | | | | | |
| | 10 | 5 | V1.25-5B | FV1.25-5B | | 5.3 (.209) | 8.5 (.335) | 22.7 (.894) | 7.2 (.284) | | | | | | | | | |
| | 1/4 | 6 | V1.25-6B | FV1.25-6B | | 6.4 (.252) | 13.5 (.532) | 28.2(1.110) | 11.7 (.461) | 1.5 (.059) | | | | | | | 500 | |
| 16 to 14 (1.04 to 2.63) | 5-6 | 3.5 | V2-YS3B | - | | 3.7 (.146) | 6.4 (.252) | 18.6 (.732) | 6.3 (.248) | 1.5 (.059) | 9.0 (.354) | 3.9 (.154) | 4.5 (.177) | 0.8 (.031) | Blue | YNT-1614 YA-1 YA-2 YA-4 BCT-0514L | 1,000 | |
| | 5-6 | 3.5 | V2-T3B | FV2-T3B | | 3.7 (.146) | 7.5 (.295) | 17.7 (.697) | 5.2 (.205) | | | | | | | | | |
| | 5-6 | 3.5 | V2-S3B | - | | 3.7 (.146) | 8.5 (.335) | 19.0 (.748) | 7.2 (.284) | | | | | | | | | |
| | 5-6 | 3.5 | V2-3B | FV2-3B | | 3.7 (.146) | 8.5 (.335) | 21.2 (.835) | 7.2 (.284) | | | | | | | | | |
| | 8 | 4 | V2-T4B | FV2-T4B | | 4.3 (.169) | 7.5 (.295) | 17.7 (.696) | 5.2 (.205) | | | | | | | | | |
| | 8 | 4 | V2-S4B | - | | 4.3 (.169) | 8.5 (.335) | 19.0 (.748) | 7.2 (.284) | | | | | | | | | |
| | 8 | 4 | V2-E4B | FV2-E4B | | 4.3 (.169) | 8.5 (.335) | 19.4 (.764) | 7.3 (.287) | | | | | | | | | |
| | 8 | 4 | V2-4B | FV2-4B | | 4.3 (.169) | 8.5 (.335) | 21.2 (.835) | 7.3 (.287) | | | | | | | | | |
| | 10 | 5 | V2-5B | FV2-5B | | 5.3 (.209) | 8.5 (.335) | 21.2 (.835) | 7.3 (.287) | | | | | | | | | |
| 1/4 | 6 | V2-6B | FV2-6B | 6.4 (.252) | 13.5 (.532) | 28.2(1.110) | 11.7 (.461) | 1.5 (.059) | 500 | | | | | | | | | |
| 12 to 10 (2.63 to 6.64) | 5-6 | 3.5 | V5.5-S3B | FV5.5-S3B | | 3.7 (.146) | 7.6 (.299) | 24.7 (.972) | 6.2 (.244) | 1.5 (.059) | 13.5 (.531) | 5.4 (.213) | 6.8 (.268) | 1.0 (.039) | Yellow | YNT-1210S YA-4 BCT-0514L | 500 | |
| | 5-6 | 3.5 | V5.5-3B | - | | 3.7 (.146) | 8.5 (.335) | 26.2(1.032) | 7.5 (.295) | | | | | | | | | |
| | 8 | 4 | V5.5-S4B | FV5.5-S4B | | 4.3 (.169) | 7.6 (.299) | 24.7 (.972) | 6.2 (.244) | | | | | | | | | |
| | 8 | 4 | V5.5-4B | FV5.5-4B | | 4.3 (.169) | 8.5 (.335) | 26.2(1.032) | 7.5 (.295) | | | | | | | | | |
| | 10 | 5 | V5.5-S5B | FV5.5-S5B | | 5.3 (.209) | 7.6 (.299) | 24.7 (.972) | 6.2 (.244) | | | | | | | | | |
| | 10 | 5 | V5.5-5B | FV5.5-5B | | 5.3 (.209) | 8.5 (.335) | 26.2(1.032) | 7.5 (.295) | | | | | | | | | |
| | 10 | 5 | V5.5-E5B | FV5.5-E5B | | 5.3 (.209) | 9.5 (.374) | 24.2 (.953) | 7.5 (.295) | | | | | | | | | |
| | 1/4 | 6 | - | FV5.5-6B | | 6.4 (.252) | 13.5 (.532) | 33.2(1.307) | 12.2 (.480) | | | | | | | | 250 | |

- Note: 1) *The crimping will be more secure if the total cross-sectional area of the wire is at least 0.5 mm².
 Examples: If the cross-sectional area of the wire is 0.3 mm², fold the wire in two when crimping the terminal.
 If the cross-sectional area of the wire is 0.5 mm², crimp the terminal onto the wire as it is.
- 2) The part numbers indicated in the above table are for products with a brazed seam.
 When ordering products with a butted seam, add the prefix "WS" to the part number (ex. V2-4B → **VWS2-4B**).
- 3) To order products with nylon insulation, change the "V" in the part number prefix to "N" (ex. V2-T4B → **N2-T4B**).
 Because nylon absorbs moisture, care must be taken concerning storage.
- 4) Delivery lead times may vary depending on the product. Contact JST for details.

Solderless terminals

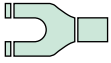

FLANGED SPADE TONGUE (B type) Vinyl-insulated (funnel-entry)

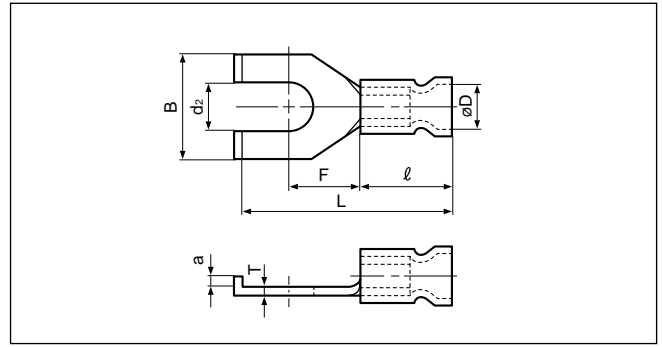
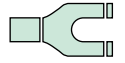

Certificate No.: E42024 LR20812

| Applicable Wire AWG#(mm²) | Stud size | | Part No. | Standard | Dimensions mm (in.) | | | | | | | | Color | Tool No. | Qty/box |
|------------------------------|-----------|--------|------------|----------|---------------------|-------------|-------------|-------------|------------|-------------|------------|------------|--------|---|---------|
| | American | Metric | | | d ₂ | B | L | F | a | ℓ | ø D | T | | | |
| 22 to 16 (0.25 to 1.65) | 1/4 | 6 | FVX1.25-6B | | 6.4 (.252) | 13.5 (.531) | 30.0(1.181) | 11.7 (.461) | 1.5 (.059) | 10.8 (.425) | 4.0 (.157) | 0.8 (.031) | Red | YNT-2216 YA-1 YA-2 YA-4 BCT-0514L | — |
| 16 to 14 (1.04 to 2.63) | 5-6 | 3.5 | FVX2-T3B | | 3.7 (.146) | 7.5 (.295) | 19.5 (.768) | 5.2 (.205) | 1.5 (.059) | 10.8 (.425) | 4.6 (.181) | 0.8 (.031) | Blue | YNT-1614 YA-1 YA-2 YA-4 BCT-0514L | 1,000 |
| | 8 | 4 | FVX2-T4B | | 4.3 (.169) | 7.5 (.295) | 19.5 (.768) | 5.2 (.205) | 1.0 (.039) | | | | | | |
| | 8 | 4 | FVX2-E4B | | 4.3 (.169) | 8.5 (.335) | 21.2 (.835) | 7.3 (.287) | 1.5 (.059) | | | | | | |
| | 1/4 | 6 | FVX2-6B | | 6.4 (.252) | 13.5 (.531) | 30.0(1.181) | 11.7 (.461) | 1.5 (.059) | | | | | | |
| 12 to 10 (2.63 to 6.64) | 10 | 5 | FVX5.5-E5B | | 5.3 (.209) | 9.6 (.378) | 24.7 (.972) | 7.5 (.295) | 1.5 (.059) | 14.0 (.551) | 6.8 (.268) | 1.0 (.039) | Yellow | YNT-1210S YA-4 BCT-0514L | 500 |

- Note:1) The part numbers indicated in the above table are for products with a brazed seam.
When ordering products with a butted seam, add the prefix "WS" to the part number (ex. FVX2-4B → **FVXWS2-4B**).
- 2) *The crimping will be more secure if the total cross-sectional area of the wire is at least 0.5 mm².
Examples: If the cross-sectional area of the wire is 0.3 mm², fold the wire in two when crimping the terminal.
If the cross-sectional area of the wire is 0.5 mm², crimp the terminal onto the wire as it is.
- 3) Delivery lead times may vary depending on the product. Contact JST for details.

Solderless terminals

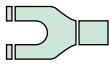

FLANGED SPADE TONGUE (B type) Vinyl-insulated with copper sleeve

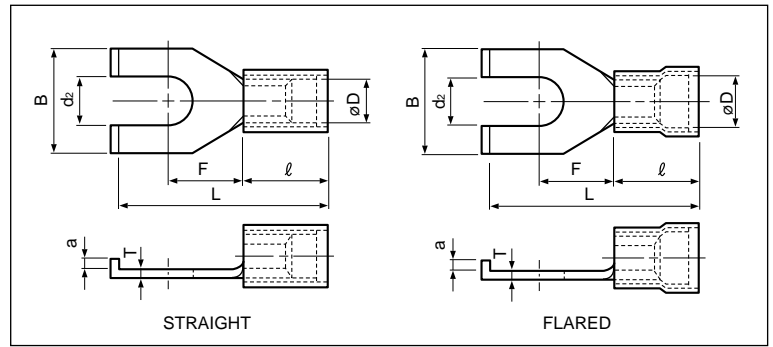
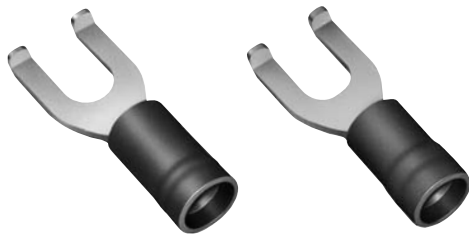
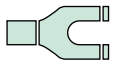

Certificate No.: E42024 LR20812

| Applicable Wire AWG#(mm ²) | Stud size | | Part No. | | Standard | Dimensions mm (in.) | | | | | | | | | | Color | Tool No. | Qty/box |
|---|-----------|-----------|-------------|-------------|-------------|---------------------|-------------|-------------|-------------|------------|-------------|------------|------------|------------|--------|---|------------|---------|
| | American | Metric | Straight | Flared | | d ₂ | B | L | F | a | ℓ | ø D | | T | | | | |
| | | | | | | | | | | | | Str. | Fid. | | | | | |
| 26 to 22 (0.2 to 0.5) | 1-2 | 2 | VD0.5-2B | — | | 2.2 (.087) | 4.6 (.181) | 15.6 (.614) | 4.5 (.177) | 1.0 (.039) | 8.0 (.315) | 2.2 (.087) | 2.5 (.098) | 0.5 (.020) | Yellow | YNT-2622 YA-1, YA-2 BCT-0514L | 1,000 | |
| 22 to 16 *(0.25 to 1.65) | 5-6 | 3.5 | VD1.25-YS3B | — | | 3.7 (.146) | 6.4 (.252) | 19.0 (.748) | 6.3 (.248) | 0.8 (.031) | 9.6 (.378) | 3.5 (.138) | 4.0 (.157) | 0.8 (.031) | Red | YNT-2216 YA-1 YA-2 YA-4 BCT-0514L | 1,000 | |
| | 5-6 | 3.5 | VD1.25-S3B | FVD1.25-S3B | | 3.7 (.146) | 7.5 (.295) | 17.9 (.705) | 5.1 (.201) | 1.5 (.059) | | | | | | | | |
| | 5-6 | 3.5 | VD1.25-3B | FVD1.25-3B | | 3.7 (.146) | 8.5 (.335) | 22.3 (.878) | 7.2 (.283) | 0.8 (.031) | | | | | | | | |
| | 8 | 4 | VD1.25-YS4B | — | | 4.3 (.169) | 6.4 (.252) | 19.0 (.748) | 6.3 (.248) | 0.8 (.031) | | | | | | | | |
| | 8 | 4 | VD1.25-S4B | FVD1.25-S4B | | 4.3 (.169) | 7.5 (.295) | 17.9 (.705) | 5.1 (.201) | 1.5 (.059) | | | | | | | | |
| | 8 | 4 | VD1.25-4B | FVD1.25-4B | | 4.3 (.169) | 8.5 (.335) | 23.3 (.917) | 7.2 (.283) | 0.8 (.031) | | | | | | | | |
| | 10 | 5 | VD1.25-5B | FVD1.25-5B | | 5.3 (.209) | 8.5 (.335) | 23.3 (.917) | 7.2 (.283) | 1.5 (.059) | | | | | | | | |
| 1/4 | 6 | VD1.25-6B | FVD1.25-6B | 6.4 (.252) | 13.5 (.531) | 28.8(1.134) | 11.7 (.461) | 1.5 (.059) | 500 | | | | | | | | | |
| 16 to 14 (1.04 to 2.63) | 5-6 | 3.5 | VD2-YS3B | — | | 3.7 (.146) | 6.4 (.252) | 19.2 (.756) | 6.3 (.248) | 0.8 (.031) | 9.6 (.378) | 4.1 (.161) | 4.7 (.185) | 0.8 (.031) | Blue | YNT-1614 YA-1 YA-2 YA-4 BCT-0514L | 1,000 | |
| | 5-6 | 3.5 | VD2-T3B | FVD2-T3B | | 3.7 (.146) | 7.5 (.295) | 18.3 (.720) | 5.2 (.205) | 1.5 (.059) | | | | | | | | |
| | 5-6 | 3.5 | VD2-S3B | — | | 3.7 (.146) | 8.5 (.335) | 19.6 (.772) | 7.2 (.283) | 0.8 (.031) | | | | | | | | |
| | 5-6 | 3.5 | VD2-3B | FVD2-3B | | 3.7 (.146) | 8.5 (.335) | 21.8 (.858) | 7.2 (.283) | 1.5 (.059) | | | | | | | | |
| | 8 | 4 | VD2-T4B | — | | 4.3 (.169) | 7.5 (.295) | 18.3 (.720) | 5.2 (.205) | 0.8 (.031) | | | | | | | | |
| | 8 | 4 | VD2-S4B | — | | 4.3 (.169) | 8.5 (.335) | 19.6 (.772) | 7.2 (.283) | 1.5 (.059) | | | | | | | | |
| | 8 | 4 | VD2-E4B | — | | 4.3 (.169) | 8.5 (.335) | 20.0 (.787) | 7.3 (.287) | 1.0 (.039) | | | | | | | | |
| | 8 | 4 | VD2-4B | FVD2-4B | | 4.3 (.169) | 8.5 (.335) | 21.8 (.858) | 7.3 (.287) | 1.5 (.059) | | | | | | | | |
| 10 | 5 | VD2-5B | FVD2-5B | 5.3 (.209) | 8.5 (.335) | 21.8 (.858) | 7.3 (.287) | 1.5 (.059) | 500 | | | | | | | | | |
| 1/4 | 6 | VD2-6B | FVD2-6B | 6.4 (.252) | 13.5 (.531) | 28.8(1.134) | 11.7 (.461) | 1.5 (.059) | 500 | | | | | | | | | |
| 12 to 10 (2.63 to 6.64) | 5-6 | 3.5 | VD5.5-S3B | FVD5.5-S3B | | 3.7 (.146) | 7.6 (.299) | 25.2 (.992) | 6.2 (.244) | 1.5 (.059) | 14.0 (.551) | 5.7 (.224) | 6.5 (.256) | 1.0 (.039) | Yellow | YNT-1210S YA-4 BCT-0514L | 500 | |
| | 5-6 | 3.5 | VD5.5-3B | FVD5.5-3B | | 3.7 (.146) | 8.5 (.335) | 26.7(1.051) | 7.5 (.295) | | | | | | | | | |
| | 8 | 4 | VD5.5-S4B | FVD5.5-S4B | | 4.3 (.169) | 7.6 (.299) | 25.2 (.992) | 6.2 (.244) | | | | | | | | | |
| | 8 | 4 | VD5.5-4B | — | | 4.3 (.169) | 8.5 (.335) | 26.7(1.051) | 7.5 (.295) | | | | | | | | | |
| | 10 | 5 | VD5.5-5B | FVD5.5-5B | | 5.3 (.209) | 8.5 (.335) | 26.7(1.051) | 7.5 (.295) | | | | | | | | | |
| | 10 | 5 | VD5.5-E5B | FVD5.5-E5B | | 5.3 (.209) | 9.5 (.374) | 24.7 (.972) | 7.5 (.295) | | | | | | | | | |
| | 1/4 | 6 | VD5.5-6B | FVD5.5-6B | | 6.4 (.252) | 13.5 (.531) | 33.7(1.367) | 12.2 (.480) | | | | | | | | 1.5 (.059) | 250 |

Note: 1) The part numbers indicated in the above table are for products with a brazed seam.
 When ordering products with a butted seam, add the prefix "WS" to the part number (ex. FVD2-4B → **FVDWS2-4B**).
 2) To order products with nylon insulation, change the "V" in the part number prefix to "N" (ex. VD2-4B → **ND2-4B**).
 Because nylon absorbs moisture, care must be taken concerning storage.
 3) Delivery lead times may vary depending on the product. Contact JST for details.